

# ELOK

60mm Backset

Sliding Screw Design.  
Drill hole to actual position

## Hole-drilling Drawing

Ratio 1:1

Drill holes as to this drawing

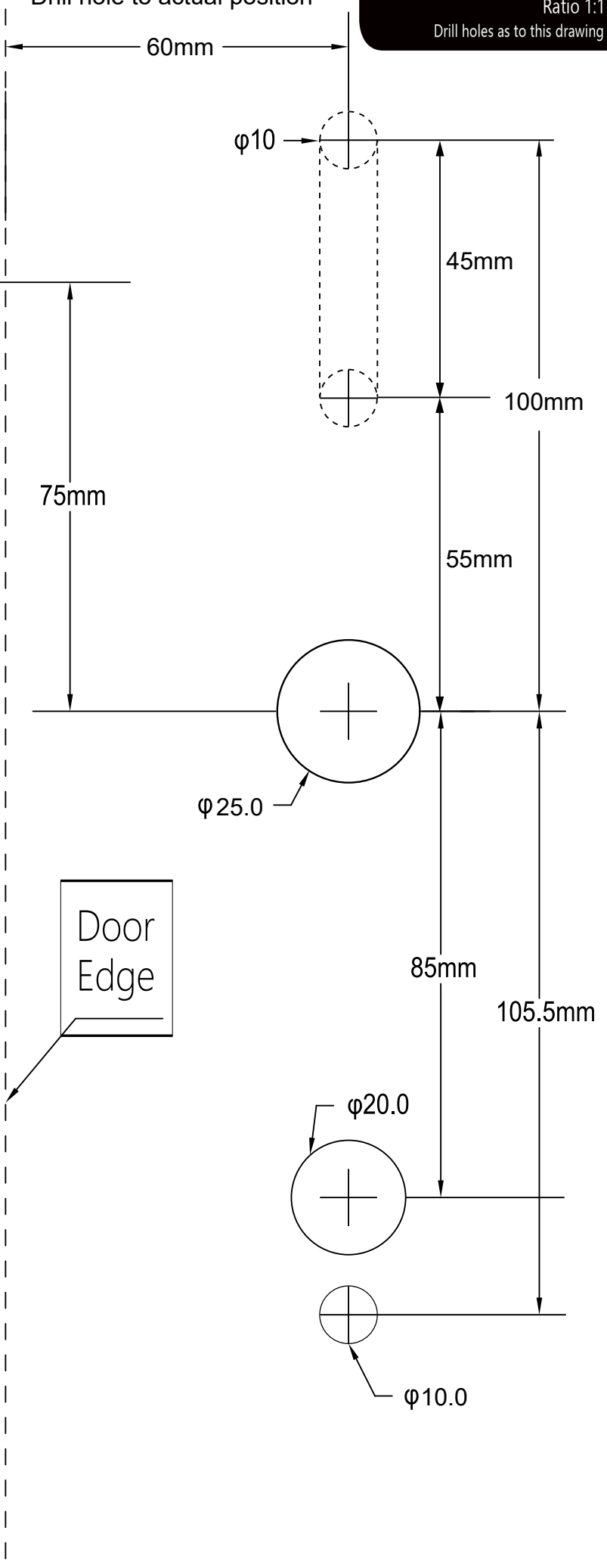
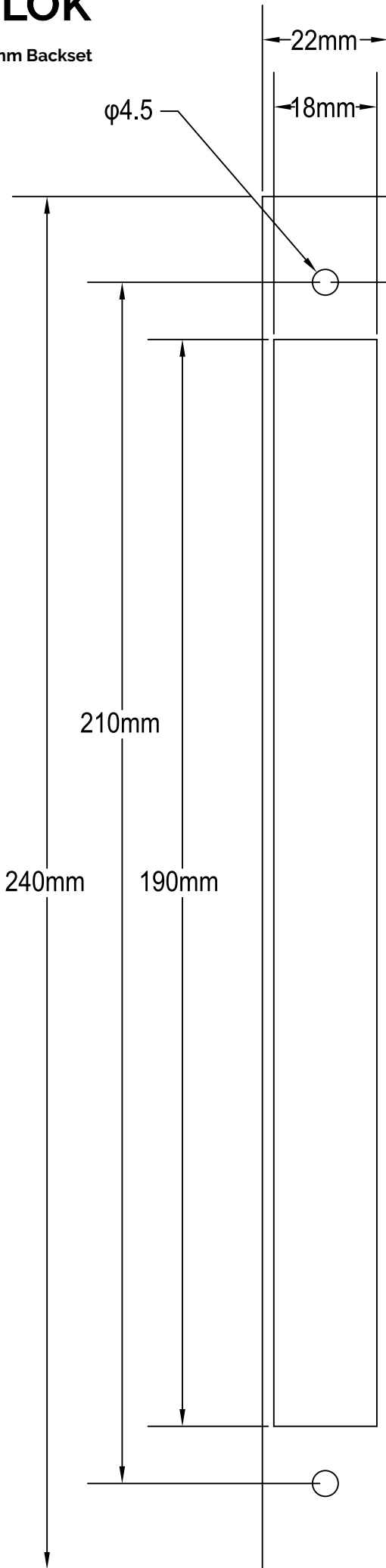

Door  
Edge